

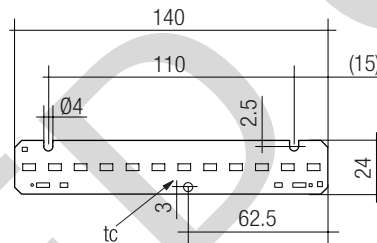

TALEXmodule STARK LLE 24-140-650 STARK LLE

Product description

- Ideal for linear and panel lights
- Luminous flux range 630 up to 800 lm
- LED system solution with outstanding system efficiency up to 114 lm/W, consisting of linear LED modules and dimmable LED control gear LCAI 080/0350
- Efficiency of the module up to 127 lm/W
- High colour rendering index CRI > 80
- Small colour tolerance MacAdam 3[®]
- Small luminous flux tolerances
- Colour temperatures 3,000 K and 4,000 K
- Perfectly uniform light, even if several LED modules are used together in a line
- Push terminals for quick and simple wiring of LED module to LED module
- Simple installation (e.g. screws)
- Long life-time: 50,000 hours
- 5-year guarantee



Technical data

Beam characteristic	120°
Ambient temperature t_a	-30 ... +45 °C
Typ. tp point	65 °C
Risk group (EN 62471:2008)	0
Type of protection	IP00

Ordering data

Type	Article number	Colour temperature	Packaging carton	Weight per pc.
TALEXmodule STARK-LLE24-140-650-830-CLA	89601894	3,000 K	100 pc(s).	0.015 kg
TALEXmodule STARK-LLE24-140-650-840-CLA	89601906	4,000 K	100 pc(s).	0.015 kg



Standards, page 3

Colour temperatures and tolerances, page 6

Specific technical data

Type [®]	Photo-metric code	Typ. luminous flux at $t_p = 25\text{ °C}$ ^①	Typ. luminous flux at $t_p = 65\text{ °C}$ ^①	Typ. forward current ^{② ③}	Min. forward voltage at $t_p = 65\text{ °C}$	Max. forward voltage at $t_p = 25\text{ °C}$	Typ. power consumption at $t_p = 65\text{ °C}$ ^④	Efficacy of the module at $t_p = 25\text{ °C}$	Efficacy of the module at $t_p = 65\text{ °C}$	Efficacy of the system at $t_p = 65\text{ °C}$	Colour rendering index CRI	Energy classification
Operating mode HE at 300 mA												
STARK-LLE24-140-650-830-CLA	830/359	660 lm	630 lm	300 mA	16.6 V	19.5 V	5.4 W	120 lm/W	118 lm/W	109 lm/W	> 80	A+
STARK-LLE24-140-650-840-CLA	840/359	700 lm	670 lm	300 mA	16.6 V	19.5 V	5.4 W	127 lm/W	124 lm/W	114 lm/W	> 80	A+
Operating mode HO at 350 mA												
STARK-LLE24-140-650-830-CLA	830/359	760 lm	730 lm	350 mA	16.9 V	19.8 V	6.4 W	116 lm/W	114 lm/W	105 lm/W	> 80	A+
STARK-LLE24-140-650-840-CLA	840/359	800 lm	770 lm	350 mA	16.9 V	19.8 V	6.4 W	123 lm/W	121 lm/W	111 lm/W	> 80	A+

^① Tolerance range for optical and electrical data: ±10 %.

^② Max. permissible repetitive peak current: 480 mA.

^③ Max. permissible surge current: 1 A, duration max. 10 μs.

^④ Central measurement over the complete module.

[®] HE ... high efficiency, HO ... high output.

Product description

- Linear cover / diffusor for LLE 24
- Protection against direct touch for non-SELV applications
- Fast snap on mounting on to LLE 24 with clips or plastic washers
- High transmission: transparent 94 %, semi-transparent 87 %, diffuse 76 %
- Linear lense made of PMMA
- Tolerances: ± 1 mm for 579 mm length (ends finished),
+ 20 mm for 1,200 / 1,500 / 1,600 / 1,800 mm length (ends raw)

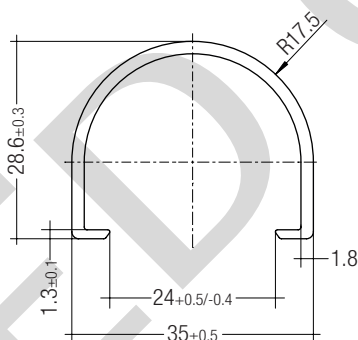
**Ordering data**

Type	Article number	Colour	Length	Packaging carton	Weight per pc.
LINEAR COVER SY Transparent 1600mm	28000338	Transparent	1,600 mm	12 pc(s).	0.272 kg
LINEAR COVER SY Frosted 1800 mm	28000437	Semi-transparent	1,800 mm	12 pc(s).	0.308 kg
LINEAR COVER SY Frosted 1600mm	28000339	Semi-transparent	1,600 mm	12 pc(s).	0.272 kg
LINEAR COVER SY Frosted 1500mm	28000435	Semi-transparent	1,500 mm	12 pc(s).	0.257 kg
LINEAR COVER SY Frosted 1200mm	28000422	Semi-transparent	1,200 mm	12 pc(s).	0.205 kg
LINEAR COVER SY Frosted 597mm	28000340	Semi-transparent	597 mm	12 pc(s).	0.102 kg
LINEAR COVER SY Diffuse 1800mm	28000438	Diffuse	1,800 mm	12 pc(s).	0.308 kg
LINEAR COVER SY Diffuse 1600mm	28000341	Diffuse	1,600 mm	12 pc(s).	0.272 kg
LINEAR COVER SY Diffuse 1500mm	28000436	Diffuse	1,500 mm	12 pc(s).	0.257 kg
LINEAR COVER SY Diffuse 1200mm	28000434	Diffuse	1,200 mm	12 pc(s).	0.205 kg
LINEAR COVER SY Diffuse 597mm	28000342	Diffuse	597 mm	12 pc(s).	0.102 kg

Standards

IEC 62031
IEC 62471
IEC 61000-4-2

Photometric code

Key for photometric code, e. g. 830 / 349

1 st digit	2 nd + 3 rd digit	4 th digit	5 th digit	6 th digit
Code CRI	Colour temperature in Kelvin x 100	McAdams initial	McAdams after 25% of the life-time (max.6000h)	Lumen maintenance after 25% of the life-time (max.6000h)
				Code Remaining lumen
7 67 – 76				7 ≥ 70 %
8 77 – 86				8 ≥ 80 %
9 87 – ≥90				9 ≥ 90 %

Thermal design and heat sink

The rated life of TALEX products depends to a large extent on the temperature. If the permissible temperature limits are exceeded, the life of the TALEXmodule STARK LLE will be greatly reduced or the TALEXmodule STARK LLE may be destroyed.

tc point, ambient temperature and life-time

The temperature at tp reference point is crucial for the light output and life-time of a TALEX product.

For TALEXmodule STARK LLE a tp temperature of 65 °C has to be complied in order to achieve an optimum between heat sink requirements, light output and life-time.

Compliance with the maximum permissible reference temperature at the tp point must be checked under operating conditions in a thermally stable state. The maximum value must be determined under worst-case conditions for the relevant application.

The tc and tp temperature of LED modules from Tridonic are measured at the same reference point.

Mounting instruction

None of the components of the TALEXmodule STARK LLE (substrate, LED, electronic components etc.) may be exposed to tensile or compressive stresses.

Max. torque for fixing: 0.5 Nm.

The LED modules are mounted onto a heat sink with min. 2 screws per module. In order not to damage the modules only rounded head screws and an additional plastic flat washer should be used.



Chemical substance may harm the LED module. Chemical reactions could lead to colour shift, reduced luminous flux or a total failure of the module caused by corrosion of electrical connections.

Materials which are used in LED applications (e.g. sealings, adhesives) must not produce dissolver gas. They must not be condensation curing based, acetate curing based or contain sulfur, chlorine or phthalate. Avoid corrosive atmosphere during usage and storage.

**EOS/ESD safety guidelines**

The device / module contains components that are sensitive to electrostatic discharge and may only be installed in the factory and on site if appropriate EOS/ESD protection measures have been taken. No special measures need be taken for devices/modules with enclosed casings (contact with the pc board not possible), just normal installation practice. Please note the requirements set out in the document EOS / ESD guidelines (Guideline_EOS_ESD.pdf) at: <http://www.tridonic.com/com/en/technical-data.asp>

Heat sink values**TALEXmodule STARK LLE**

ta	tp	Forward current	R _{th, hs-a}	Cooling area
25 °C	65 °C	300 mA	11.35 K/W	59 cm ²
25 °C	65 °C	350 mA	9.91 K/W	67 cm ²
35 °C	65 °C	300 mA	8.21 K/W	81 cm ²
35 °C	65 °C	350 mA	7.25 K/W	92 cm ²
45 °C	65 °C	300 mA	5.28 K/W	126 cm ²
45 °C	65 °C	350 mA	4.66 K/W	143 cm ²

Notes

The actual cooling surface can differ because of the material, the structural shape, outside influences and the installation situation. Depending on the heat sink a heat conducting paste or heat conducting film might be necessary to keep the specified tp temperature.

Thermal behaviour

storage temperature	-40 ... +85 °C
operating temperature t_a	-30 ... +45 °C
t_p (at typ. current)	65 °C
t_c max. (at typ. current)	85 °C
max. humidity	0 ... 80 %

* not condensating

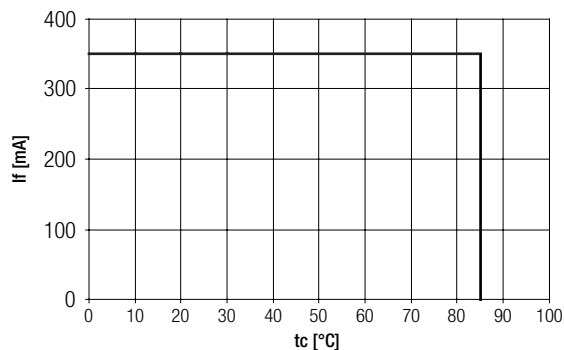

Life-time, lumen maintenance and failure rate

The light output of an LED Module decreases over the life-time, this is characterized with the L value.

L70 means that the LED module will give 70 % of its initial luminous flux. This value is always related to the number of operation hours and therefore defines the life-time of an LED module.

As the L value is a statistical value and the lumen maintenance may vary over the delivered LED modules.

The B value defines the amount of modules which are below the specific L value, e.g. L70B10 means 10 % of the LED modules are below 70 % of the initial luminous flux, respectively 90 % will be above 70 % of the initial value. In addition the percentage of failed modules (fatal failure) is characterized by the C value.

The F value is the combination of the B and C value. That means for F degradation and complete failures are considered, e.g. L70F10 means 10 % of the LED modules may fail or be below 70 % of the initial luminous flux.

Lumen maintenance for TALEXmodule STARK LLE-24-140-650

Forward current	t_p temperature	L90 / F10		L80 / F10		L70 / F10	
		L90 / F10	L90 / F50	L80 / F10	L80 / F50	L70 / F10	L70 / F50
300 mA	55 °C	15,000 h	22,000 h	31,000 h	46,000 h	49,000 h	> 60,000 h
	65 °C	12,000 h	18,000 h	25,000 h	38,000 h	40,000 h	> 60,000 h
	75 °C	10,000 h	15,000 h	21,000 h	31,000 h	33,000 h	49,000 h
350 mA	55 °C	12,000 h	18,000 h	26,000 h	39,000 h	42,000 h	> 60,000 h
	65 °C	10,000 h	15,000 h	21,000 h	32,000 h	34,000 h	51,000 h
	75 °C	8,000 h	12,000 h	17,000 h	26,000 h	28,000 h	41,000 h

Selection of the LED control gear

TALEXmodule STARK LLE can be operated either from SELV LED control gears or from LED control gears with LV output voltage.



TALEXmodule STARK LLE are basic isolated against ground and can be mounted directly on earthed metal parts of the luminaire also when used in conjunction with the LED control gear LCAI 080/0350. In this case the light emitting side of the module has to be protected against direct touch (test finger). This is typically achieved by means of a non removable light distributor over the module.

Electrical supply/choice of LED control gear

TALEXmodule STARK LLE from Tridonic are not protected against overvoltages, overcurrents, overloads or short-circuit currents. Safe and reliable operation can only be guaranteed in conjunction with a LED control gear which complies with the relevant standards. The use of TALEXconverter from Tridonic in combination with TALEXmodule STARK LLE guarantees the necessary protection for safe and reliable operation.

If a LED control gear other than Tridonic TALEXconverter is used, it must provide the following protection:

- Short-circuit protection
- Overload protection
- Overtemperature protection



TALEXmodule STARK LLE must be supplied by a constant current LED control gear.

Operation with a constant voltage LED control gear will lead to an irreversible damage of the module.

Wrong polarity can damage the TALEXmodule STARK LLE.

If TALEXmodules LLE are wired in parallel and a wire breaks or a complete module fails then the current passing through the other module increases. This may reduce its life considerably. In addition there can be slight differences in light output caused by tolerances.

Wiring



Wiring examples

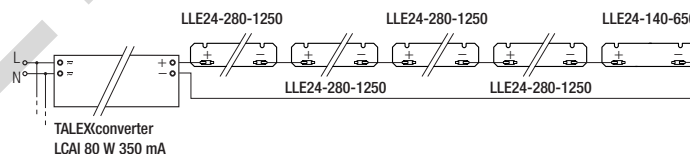

Wiring type and cross section

The wiring can be solid cable with a cross section of 0.2 to 0.75 mm². For the push-wire connection you have to strip the insulation (6–7 mm).

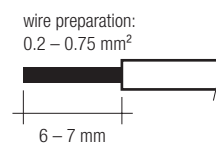

Inserting stranded wires / removing wires by lightly pressing on the push button.

Relative forward voltage and relative luminous flux

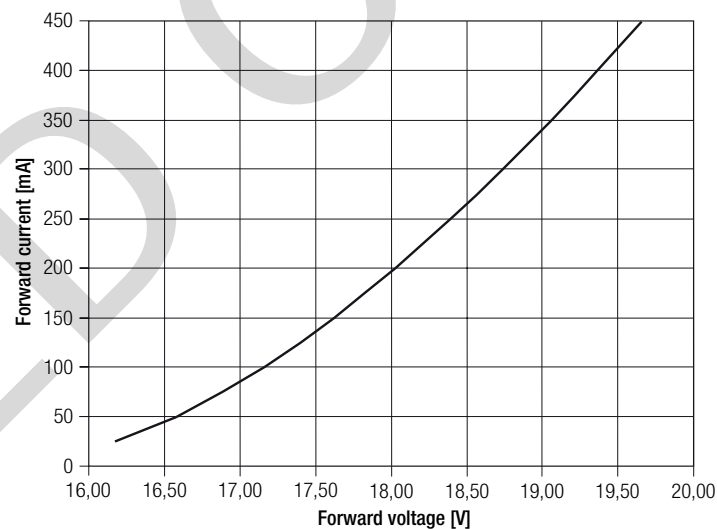
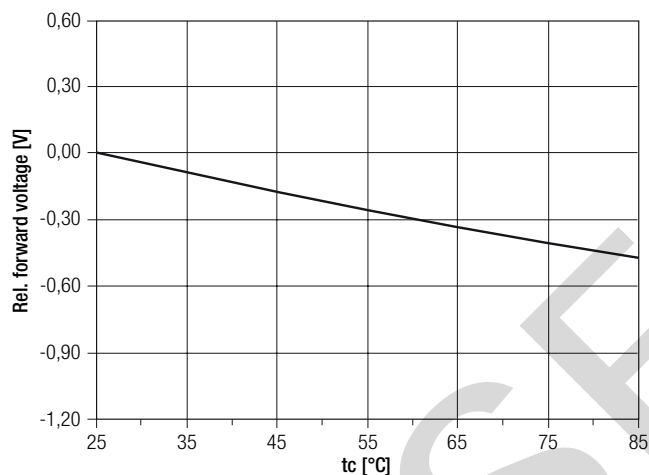
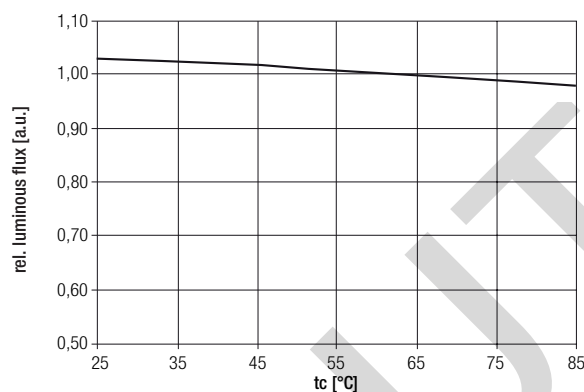
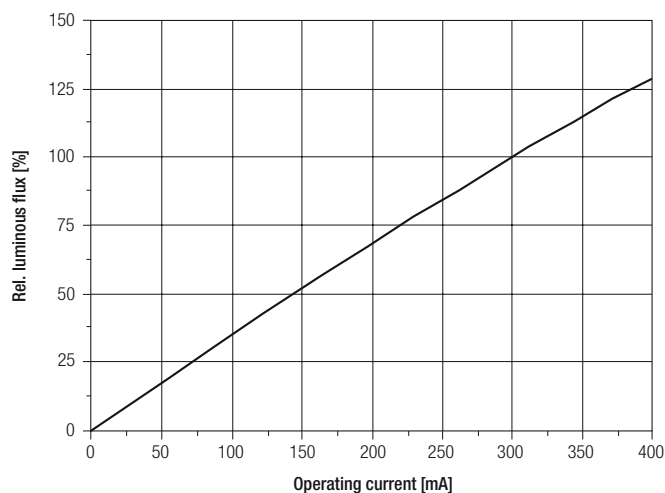

The diagrams are based on statistic values.
The real values can be different.

Optical characteristics TALEX(module STARK LLE

The optical design of the TALEX(module STARK LLE product line ensures optimum homogeneity for the light distribution.

Light distribution

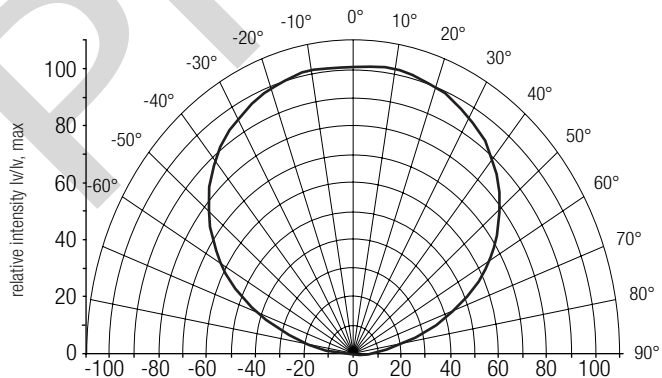

The colour temperature is measured integral over the complete module. The single LED light points can have deviations in the colour coordinates within MacAdam 7. To ensure an ideal mixture of colours and a homogenous light distribution a suitable optic (e. g. PMMA diffuser) and a sufficient spacing between module and optic (typ. 4 cm) should be used.

For further information see Design-in Guide, 3D data and photometric data on www.tridonic.com or on request.

Coordinates and tolerances according to CIE 1931

The specified colour coordinates are central measured by a current impulse with typical values of module and a duration of 100 ms.

The ambient temperature of the measurement is $t_a = 25\text{ }^\circ\text{C}$.

The measurement tolerance of the colour coordinates are ± 0.01 .

3,000 K

	x0	y0
Centre	0.4344	0.4032

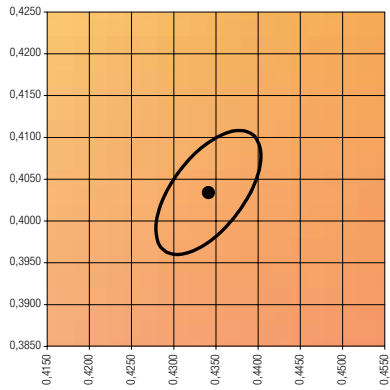

— MacAdam Ellipse: 3SDCM

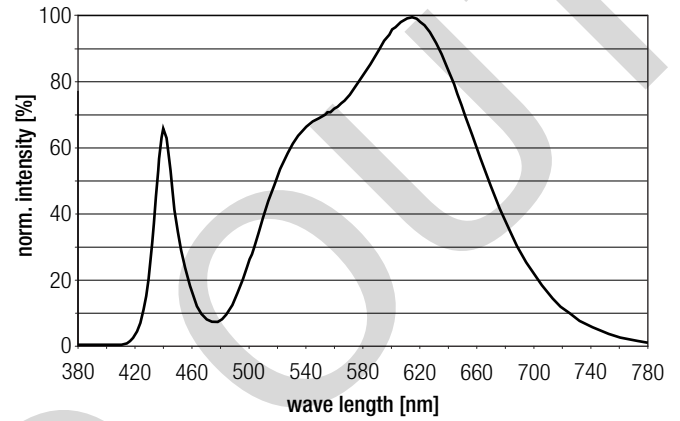

4,000 K

	x0	y0
Centre	0.3828	0.3803

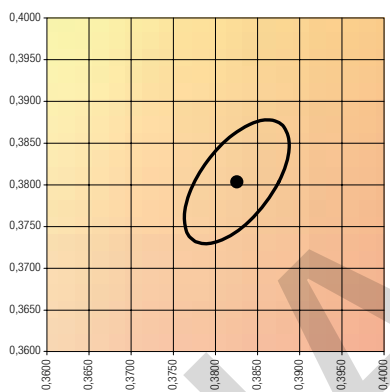

— MacAdam Ellipse: 3SDCM

