



TALEXmodule STARK LLE 16-280-650 STARK LLE

Product description

- Ideal for linear and panel lights
- Luminous flux range from 680 up to 840 lm
- Efficiency of the module up to 137 lm/W
- High colour rendering index CRI > 80
- Small colour tolerance MacAdam 4[®]
- Small luminous flux tolerances
- Colour temperatures 3,000 K and 4,000 K
- Perfectly uniform light, even if several LED modules are used together in a line
- Self-cooling (no additional heat sink required)
- Push terminals for quick and simple wiring of LED module to LED module
- Simple installation (e.g. screws)
- Long life-time: 50,000 hours
- 5-year guarantee

Technical data

Beam characteristic	120°
Ambient temperature t_a	-30 ... +45 °C
Typ. tp point	65 °C
Risk group (EN 62471:2008)	0
Type of protection	IP00

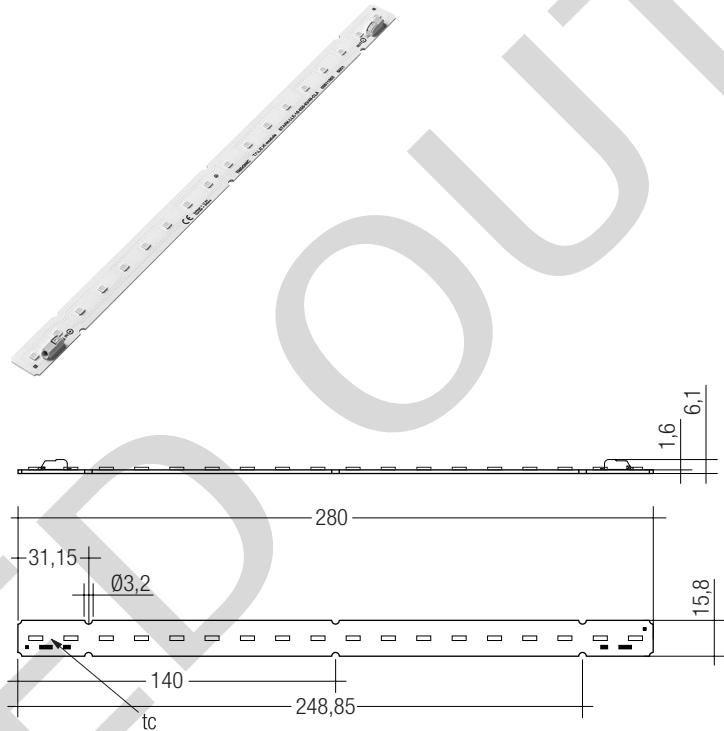

Ordering data

Type	Article number	Colour temperature	Packaging carton	Weight per pc.
TALEXmodule STARK-LLE-16-280-650-830-CLA	89601864	3,000 K	75 pc(s).	0.015 kg
TALEXmodule STARK-LLE-16-280-650-840-CLA	89601865	4,000 K	75 pc(s).	0.015 kg



Standards, page 2

Colour temperatures and tolerances, page 5

Specific technical data

Type [®]	Photo-metric code	Typ. luminous flux at $t_p = 25\text{ °C}$ [®]	Typ. luminous flux at $t_p = 65\text{ °C}$ [®]	Typ. forward current [®] [®]	Min. forward voltage at $t_p = 65\text{ °C}$	Max. forward voltage at $t_p = 25\text{ °C}$	Typ. power consumption [®]	Efficacy of the module at $t_p = 25\text{ °C}$	Efficacy of the module at $t_p = 65\text{ °C}$	Efficacy of the system at $t_p = 65\text{ °C}$	Colour rendering index CRI	Energy classification
Operating mode HE at 300 mA												
STARK-LLE-16-280-650-830-CLA	830/4xx	710 lm	680 lm	300 mA	16.4 V	19.3 V	5.3 W	134 lm/W	128 lm/W	117 lm/W	> 80	A++
STARK-LLE-16-280-650-840-CLA	840/4xx	740 lm	700 lm	300 mA	16.4 V	19.3 V	5.3 W	140 lm/W	132 lm/W	121 lm/W	> 80	A++
Operating mode HO at 350 mA												
STARK-LLE-16-280-650-830-CLA	830/4xx	810 lm	770 lm	350 mA	16.7 V	19.6 V	6.3 W	129 lm/W	122 lm/W	113 lm/W	> 80	A+
STARK-LLE-16-280-650-840-CLA	840/4xx	840 lm	800 lm	350 mA	16.7 V	19.6 V	6.3 W	133 lm/W	127 lm/W	118 lm/W	> 80	A+

[®] Tolerance range for optical and electrical data: ±10 %.

[®] Max. permissible repetitive peak current: 540 mA.

[®] Max. permissible surge current: 0.72 A, duration max. 10 µs.

[®] Integrated measurement over the whole module.

[®] HE ... high efficiency, HO ... high output.

Standards

EN 62031
 EN 62471
 EN 61347-1
 EN 61547
 EN 55015

Photometric code

Key for photometric code, e. g. 830 / 349

1 st digit	2 nd + 3 rd digit	4 th digit	5 th digit	6 th digit		
Code	CRI	Colour temperature in Kelvin x 100	McAdams initial	McAdams after 25% of the life-time (max.6000h)	Lumen maintenance after 25% of the life-time (max.6000h)	
					Code	Remaining lumen
7	67 – 76				7	≥ 70 %
8	77 – 86				8	≥ 80 %
9	87 – ≥90		9	≥ 90 %		

Thermal design and heat sink

The rated life of TALEX products depends to a large extent on the temperature. If the permissible temperature limits are exceeded, the life of the TALEXmodule STARK LLE will be greatly reduced or the TALEXmodule STARK LLE may be destroyed.

tp point, ambient temperature and life-time

The temperature at tp reference point is crucial for the light output and life-time of a TALEX product.

For TALEXmodule STARK LLE a tp temperature of 65 °C has to be complied in order to achieve an optimum between heat sink requirements, light output and life-time.

Compliance with the maximum permissible reference temperature at the tc point must be checked under operating conditions in a thermally stable state. The maximum value must be determined under worst-case conditions for the relevant application.

The tc and tp temperature of LED modules from Tridonic are measured at the same reference point.

Mounting instruction

None of the components of the TALEXmodule STARK LLE (substrate, LED, electronic components etc.) may be exposed to tensile or compressive stresses.

Max. torque for fixing: 0.5Nm.

The LED modules are mounted onto a heat sink with min. 3 screws per module. In order not to damage the modules only rounded head screws and an additional plastic flat washer should be used.



Chemical substance may harm the LED module. Chemical reactions could lead to colour shift, reduced luminous flux or a total failure of the module caused by corrosion of electrical connections.

Materials which are used in LED applications (e.g. sealings, adhesives) must not produce dissolver gas. They must not be condensation curing based, acetate curing based or contain sulfur, chlorine or phthalate. Avoid corrosive atmosphere during usage and storage.

**EOS/ESD safety guidelines**

The device / module contains components that are sensitive to electrostatic discharge and may only be installed in the factory and on site if appropriate EOS/ESD protection measures have been taken. No special measures need be taken for devices/modules with enclosed casings (contact with the pc board not possible), just normal installation practice. Please note the requirements set out in the document EOS / ESD guidelines (Guideline_EOS_ESD.pdf) at: <http://www.tridonic.com/esd-protection>

Thermal behaviour

storage temperature	-30 ... +80 °C
operating temperature t_a	-30 ... +45 °C
t_p (at typ. current)	65 °C
t_p max. (at typ. current)	75 °C
max. humidity*	0 ... 80 %

* not condensating

Life-time, lumen maintenance and failure rate

The light output of an LED Module decreases over the life-time, this is characterized with the L value.

L70 means that the LED module will give 70 % of its initial luminous flux. This value is always related to the number of operation hours and therefore defines the life-time of an LED module.

As the L value is a statistical value and the lumen maintenance may vary over the delivered LED modules.

The B value defines the amount of modules which are below the specific L value, e.g. L70B10 means 10 % of the LED modules are below 70 % of the initial luminous flux, respectively 90 % will be above 70 % of the initial value. In addition the percentage of failed modules (fatal failure) is characterized by the C value.

The F value is the combination of the B and C value. That means for F degradation and complete failures are considered, e.g. L70F10 means 10 % of the LED modules may fail or be below 70 % of the initial luminous flux.

Lumen maintenance for TALEXmodule STARK LLE-16-280-650

Operating current	t_p temperature	L70 / F50	L70 / F10
350 mA	65 °C	> 50,000 h	> 50,000 h

Selection of the LED control gear

TALEXmodule STARK LLE can be operated either from SELV LED control gears or from LED control gears with LV output voltage.



TALEXmodule STARK LLE are basic isolated up to 420 V against ground and can be mounted directly on earthed metal parts of the luminaire. If the max. output voltage of the led control gear (also against earth) is above 420 V, an additional isolation between LED module and heat sink is required (for example by isolated thermal pads) or by a suitable luminaire construction.

At voltages > 60 V an additional protection against direct touch (test finger) to the light emitting side of the module has to be guaranteed. This is typically achieved by means of a non removable light distributor over the module.

Electrical supply/choice of LED control gear

TALEXmodule STARK LLE from Tridonic are not protected against overvoltages, overcurrents, overloads or short-circuit currents. Safe and reliable operation can only be guaranteed in conjunction with a LED control gear which complies with the relevant standards. The use of TALEXconverter from Tridonic in combination with TALEXmodule STARK LLE guarantees the necessary protection for safe and reliable operation.

If a LED control gear other than Tridonic TALEXconverter is used, it must provide the following protection:

- Short-circuit protection
- Overload protection
- Overtemperature protection



TALEXmodule STARK LLE must be supplied by a constant current LED control gear.

Operation with a constant voltage LED control gear will lead to an irreversible damage of the module.

Wrong polarity can damage the TALEXmodule STARK LLE.

If TALEXmodules LLE are wired in parallel and a wire breaks or a complete module fails then the current passing through the other module increases. This may reduce its life considerably. In addition there can be slight differences in light output caused by tolerances.

Wiring

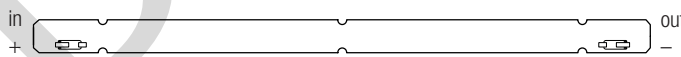

Wiring examples

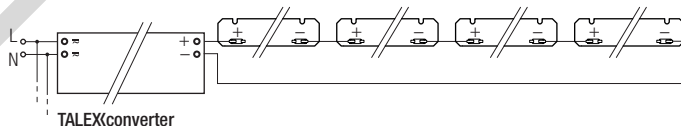

Wiring type and cross section

The wiring can be solid cable with a cross section of 0.2 to 0.75 mm². For the push-wire connection you have to strip the insulation (6–7 mm).

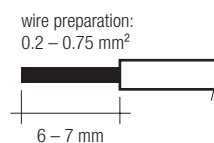

Inserting stranded wires / removing wires by lightly pressing on the push button.

Relative luminous flux vs. operating current

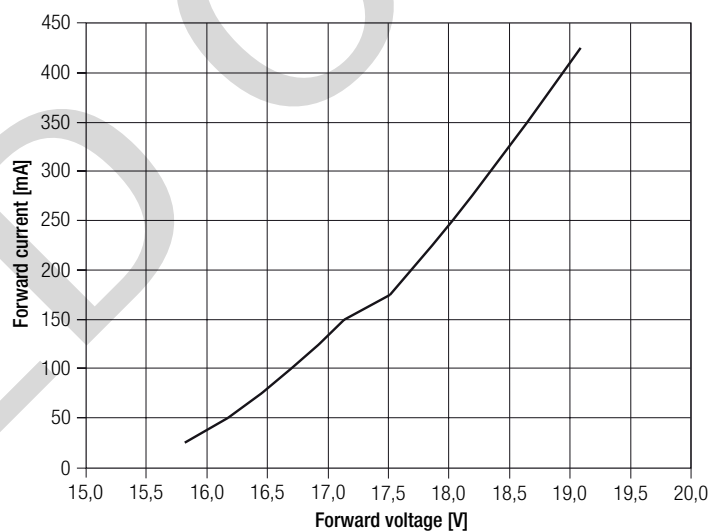
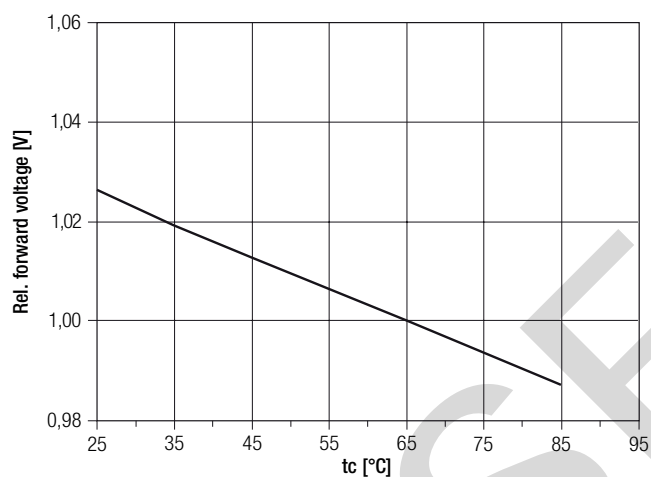
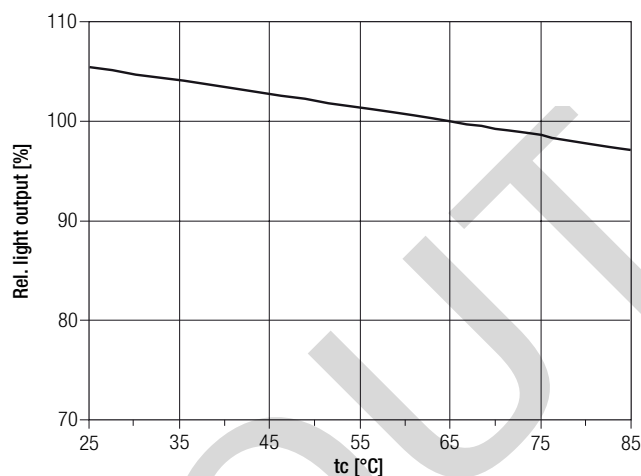
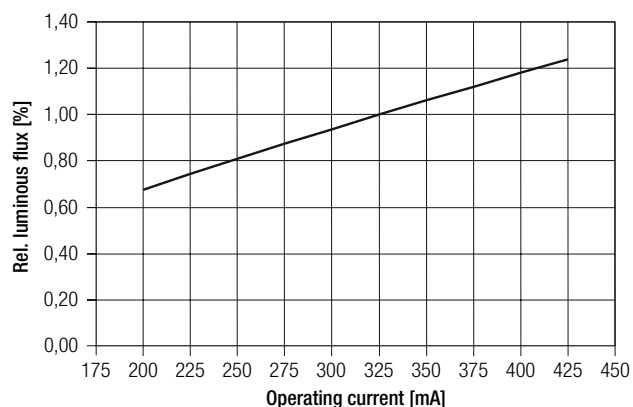

The diagrams are based on statistic values.
The real values can be different.

Optical characteristics TALEXmodule STARK LLE

The optical design of the TALEXmodule STARK LLE product line ensures optimum homogeneity for the light distribution.

Light distribution

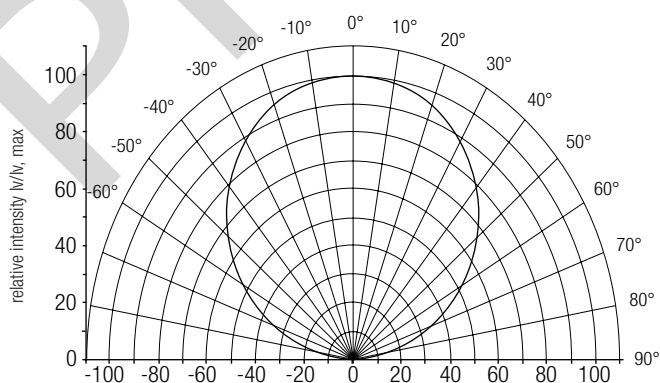

For further information see Design-in Guide, 3D data and photometric data on www.tridonic.com or on request.



The colour temperature is measured integral over the complete module. The single LED light points can have deviations in the colour coordinates within MacAdam *tbd*. To ensure an ideal mixture of colours and a homogenous light distribution a suitable optic (e. g. PMMA diffuser) and a sufficient spacing between module and optic (typ. 2 cm) should be used.

Coordinates and tolerances according to CIE 1931

The specified colour coordinates are integrally measured by a current impulse with typical values of module and a duration of 200 ms.

The ambient temperature of the measurement is $t_a = 25\text{ }^\circ\text{C}$.

The measurement tolerance of the colour coordinates are ± 0.01 .

3,000 K

	x0	y0
Centre	0.4344	0.4032

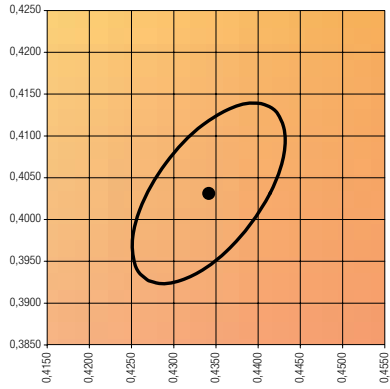

— MacAdam Ellipse: 4SDCM

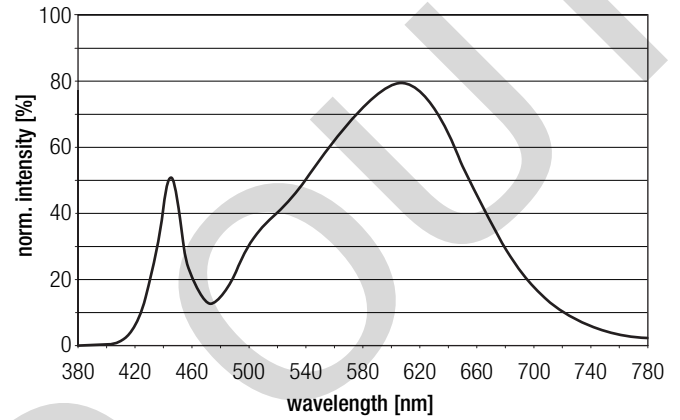

4,000 K

	x0	y0
Centre	0.3828	0.3803

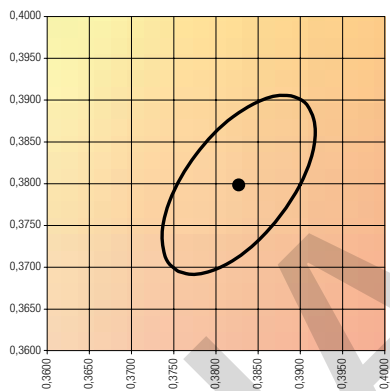

— MacAdam Ellipse: 4SDCM

