

**Driver LCU 180W 24V IP20 EXC**  
excite series

**Product description**

- Constant voltage LED Driver
- Universal input voltage range
- Constant output voltage
- Push terminals for simple wiring
- Nominal life-time up to 50,000 h (at ta 45 °C with a failure rate max. 0.2 % per 1,000 h)
- 5-year guarantee
- Complies with CLASS C from minimum to maximum load range according to EN 61000-3-2



**Properties**

- Small design
- High efficiency
- Low power loss
- Overtemperature and overload protection
- Short-circuit shutdown feature with automatic restart
- Protection class II, SELV
- Type of protection IP20
- Plastic casing white



IP20 SELV 

**Driver LCU 180W 24V IP20 EXC**  
excite series

**Technical data**

Rated supply voltage	120 – 277 V
AC voltage range	108 – 305 V
Rated current (at 230 V 50 Hz)	0.92 A
Mains frequency	50 / 60 Hz
Efficiency	> 90 %
$\lambda$ (at 230 V 50 Hz)	0.95
Max. input power in no-load operation	0.5 W
Output voltage tolerance	-0 /+5 %
Output power ( $t_a \leq 50$ °C)	180 W
Output power ( $t_a > 50$ °C)	126 W
Output power range	18 – 180 W
Starting time (output)	$\leq 0.5$ s
Turn off time (output)	$\leq 1$ s
Hold on time at power failure (Output)	10 ms
Mains surge capability (between L - N)	1 kV
Mains surge capability (between L/N - PE)	1 kV
Surge voltage at output side (against PE)	< 500 V
Ambient temperature $t_a$	-25 ... +60 °C
Ambient temperature $t_a$ (at life-time 50,000 h)	-25 ... +45 °C
Storage temperature	-40 ... +85 °C
Life-time	up to 50,000 h
Dimensions LxWxH	280 x 64 x 31 mm
Hole spacing D	253 mm

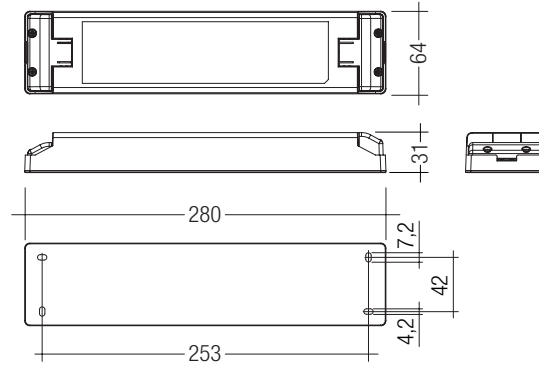

**Ordering data**

Type	Article number	Packaging carton	Packaging pallet	Weight per pc.
<b>LCU 180W 24V SR top</b>	<b>28000414</b>	10 pc(s).	400 pc(s).	0.85 kg

**Specific technical data**

Type	Max. casing temperature $t_c$	Output voltage	Max. input power	Output current range
<b>LCU 180W 24V SR top</b>	90 °C	24 V	211 W	750 – 7,500 mA

**Standards**

- EN 55015
- EN 60598-1
- EN 60598-2-22
- EN 61000-3-2
- EN 61000-3-3
- EN 61347-1
- EN 61347-2-13
- EN 61547
- EN 62384
- EN 62493

**Overload protection**

Automatic shutdown of the LED Driver if the maximum output current is exceeded. Automatic restart if the output current is below the limit.

**No-load operation**

The LED Driver is not damaged in the no-load operation. The max. output voltage (see page1) can be obtained during no-load operation.

**Over temperature protection**

Automatic shutdown of the LED Driver if the temperature limit is exceeded. Automatic restart if the temperature falls below the limit.

**Short-circuit behaviour**

In case of a short circuit on the secondary side (LED) the LED Driver switches into hiccup mode. After removal of the short-circuit fault the LED Driver will recover automatically.

**Glow wire test**

according to EN 61347-1 with increased temperature of 850 °C passed.

**Expected life-time**

Type	Output voltage	ta	35 °C	45 °C	55 °C
<b>LCU 180W 24V SR top</b>	24 V	tc	69 °C	79 °C	89 °C
		Life-time	> 100,000 h	> 50,000 h	> 25,000 h

**Maximum loading of automatic circuit breakers in relation to inrush current**

Automatic circuit breaker type	C10	C13	C16	C20	B10	B13	B16	B20	Inrush current	
Installation Ø	1.5 mm <sup>2</sup>	1.5 mm <sup>2</sup>	1.5 mm <sup>2</sup>	2.5 mm <sup>2</sup>	1.5 mm <sup>2</sup>	1.5 mm <sup>2</sup>	1.5 mm <sup>2</sup>	2.5 mm <sup>2</sup>	I <sub>max</sub>	time
<b>LCU 180W 24V SR top</b>	9	12	15	18	9	12	15	18	3.7 A	2,340 µs

This are max. values calculated out of inrush current! Please consider not to exceed the maximum rated continuous current of the circuit breaker. Calculation uses typical values from ABB series S200 as a reference. Actual values may differ due to used circuit breaker types and installation environment.

**Harmonic distortion in the mains supply (at 230 V / 50 Hz and full load) in %**

Type	THD	3	5	7	9	11
<b>LCU 180W 24V SR top</b>	14	11	5	3	1	1

**Wiring diagram**

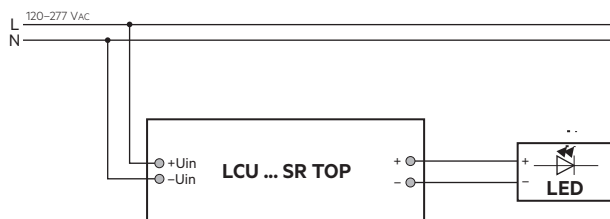

**Installation instructions**

The switching of LEDs on secondary side is not permitted. The functioning of the LCU in combination with dimming devices (e.g. PWM) cannot be guaranteed and has to be checked individually before using in combination.

To avoid the damage of the Driver, the wiring must be protected against short circuits to earth (sharp edged metal parts, metal cable clips, louver, etc.).

**Wiring type and cross section**

The wiring can be in stranded wires with ferrules or solid. For perfect function of the screw terminals the strip length should be 9–10 mm for the terminal.

The maximum secondary cable length at the terminals is 2 m. The LED wiring should be kept as short as possible to ensure good EMC.

**Input / Output terminal**

**PRI:**

20 AWG – 12 AWG

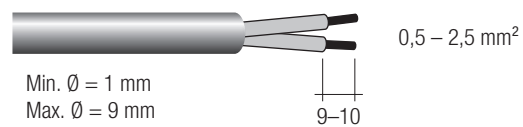

**SEC:**

20 AWG – 12 AWG

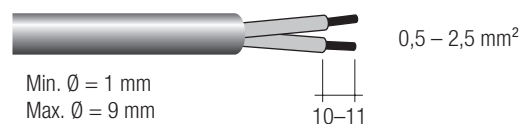

**Release of the wiring:**

The terminals have a simple push-in termination. Conductor removal via screwdriver (2.5 mm x 0.4 mm).

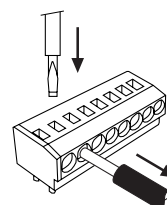

**Insulation and electric strength testing of luminaires**

Electronic devices can be damaged by high voltage. This has to be considered during the routine testing of the luminaires in production.

According to IEC 60598-1 Annex Q (informative only!) or ENEC 303-Annex A, each luminaire should be submitted to an insulation test with 500 V<sub>DC</sub> for 1 second. This test voltage should be connected between the interconnected phase and neutral terminals and the earth terminal. The insulation resistance must be at least 2MΩ.

As an alternative, IEC 60598-1 Annex Q describes a test of the electrical strength with 1500 V<sub>AC</sub> (or 1.414 x 1500 V<sub>DC</sub>). To avoid damage to the electronic devices this test must not be conducted.

**Maximum number of switching cycles**

All LED Driver are tested with 50,000 switching cycles. The actually achieved number of switching cycles is significantly higher.

**Additional information**

Additional technical information at [www.tridonic.com](http://www.tridonic.com) → Technical Data

Guarantee conditions at [www.tridonic.com](http://www.tridonic.com) → Services

Life-time declarations are informative and represent no warranty claim. No warranty if device was opened.

**Diagrams for 24 V**

Efficiency vs load

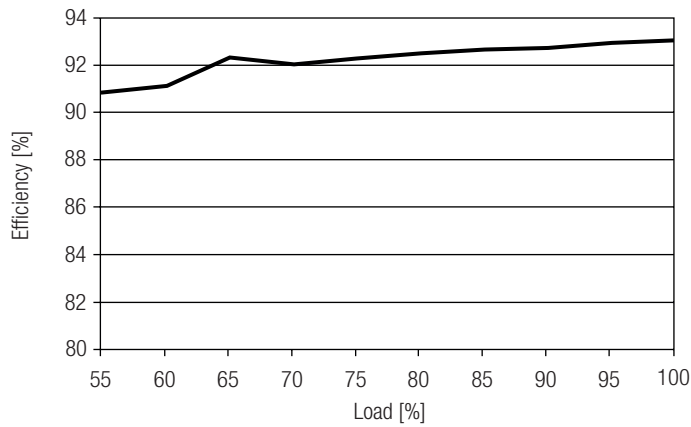

Power factor vs load

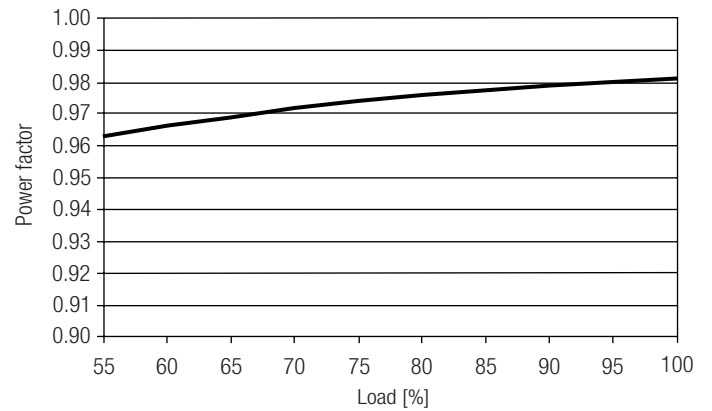

THD vs load

