



DALI MSensor 02

Multi-sensor for DALI system

Product description

- Component of the comfortDIM system (DALI standalone)
- With ambient light dependent control and motion detection
- Simple group assignment via rotary switch
- Multiple MSensors possible in a group
- Can be remote controlled
- Lighting control and motion detection can be deactivated
- Individual adjustment of the parameters with configuration software
- Multi-master compatible: Multiple control modules are possible in a DALI system
- Power supply via DALI line
- 5-year guarantee

Technical data

| | |
|---------------------------------------|----------------|
| Supply via | DALI cable |
| Current draw | 6 mA from DALI |
| Mounting height | 5 m |
| Detection angle for PIR detection | 90° |
| Detection angle for light measurement | 70° |
| Operating temperature | 0 ... +50 °C |
| Storage temperature | -25 ... +55 °C |
| Type of protection | IP20 |



Standards, page 3

Wiring diagrams and installation examples, page 3



Fig. 1

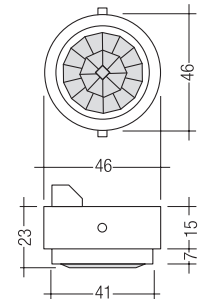

Fig. 2

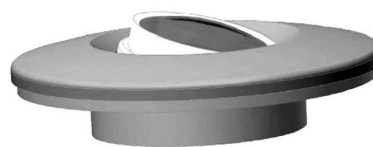
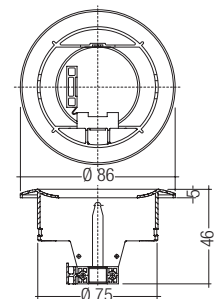

Fig. 3

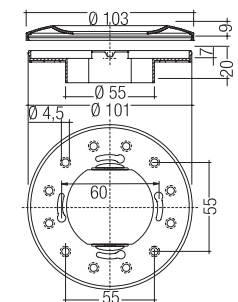
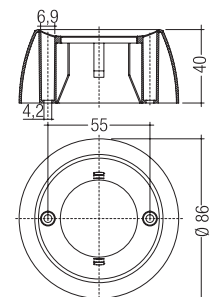

Fig. 4



Ordering data

| Type | Article number | Figure | Packaging, carton | Weight per pc. |
|---|----------------|--------|-------------------|----------------|
| DALI MSensor 02 5DPI 41f Luminaire installation | 28000897 | 1 | 12 pc(s). | 0.02 kg |
| DALI MSensor 02 5DPI 41rc Ceiling installation | 28000895 | 2 | 20 pc(s). | 0.06 kg |
| DALI MSensor 02 5DPI 41w Box installation | 28000896 | 3 | 20 pc(s). | 0.05 kg |
| DALI MSensor 02 5DPI 41rs Surface mounting | 28000894 | 4 | 20 pc(s). | 0.05 kg |

Specific technical data

| Type | Detection | | | | | | |
|----------------------------------|--|--|---------------|--------------|-----------------|---|-------------------------|
| | Ø of detection range, mounted at a height of 2.5 m | Extension of the detection area ^① | Swivel design | Swivel range | Detection angle | Light measurement at the sensor head ^② | Infra-red control range |
| DALI MSensor 02 5DPI 41f | 5 m | – | no | 0° | 90° | 10 – 650 lx | 5 m |
| DALI MSensor 02 5DPI 41rc | 5 m | 2 m | yes | ±15° | 90° | 10 – 650 lx | 5 m |
| DALI MSensor 02 5DPI 41w | 5 m | 2 m | yes | ±15° | 90° | 10 – 650 lx | 5 m |
| DALI MSensor 02 5DPI 41rs | 5 m | – | no | 0° | 90° | 10 – 650 lx | 5 m |

^① If mounted at a height of 2.5 m and swivelled through 15 °.

^② The measured value at the sensor head corresponds to approx. 15 to 2,000 lux on the surface measured.

ACCES-
SORIES

REMOTECONTROL IR6

Product description

- Optional infra-red remote control
- Switching on and off (On/Off button)
- Dimming (Up/Down button)
- Activation of automatic lighting control
- Setting the threshold control point (Set button)

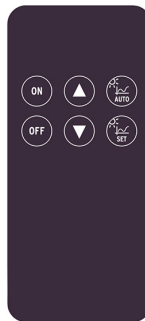

Ordering data

| Type | Article number | Dimensions L x W x H | Packaging carton | Weight per pc. |
|--------------------------|-----------------|----------------------|------------------|----------------|
| REMOTECONTROL IR6 | 28000647 | 86.5 x 40.5 x 7.2 mm | 500 pc(s). | 0.019 kg |

1. Standards

EN 61547
EN 61347-1
EN 61347-2-11
EN 55015

1.1 DALI standard

The DALI MSensor02 is designed to control control gear with DALI standard IEC 60929 (DALI V0) and IEC 62386 (DALI V1).

1.2 Glow-wire test

according to EN 61347-1 passed.

2. Common

The DALI MSensor 02 is the ideal addition to the comfortDIM series of products as it offers daylight-dependent lighting control, presence detection and remote control.

It has been designed for the following principal applications:

- Individual offices
- Open-plan offices
- Training / presentation rooms
- Corridors, passageways and garages

The DALI MSensor 02 controls a DALI group and is designed that it can be used together with the comfortDIM components (e.g. DALI XC). For this reason the DALI MSensor 02 can be addressed and grouped like an ECG, making system configuration easier. The configuration of the sensors is done by the masterCONFIGURATOR software tool (since version 2.02). For further information please refer to the DALI MSensor 02 manual on www.tridonic.com. As an option, the DALI MSensor 02 can be operated with a remote control. The remote control available with the system is the REMOTECONTROL IR6.

A maximum of 12 sensors can be operated on one DALI circuit. This restriction is due to the permitted data traffic on the DALI circuit.

To use the DALI MSensor 02 in conjunction with an external system some modes are available. To ensure a proper function please take account of the advices in the DALI MSensor 02 manual on www.tridonic.com.

3. Installation

- The DALI MSensor 02 must not be connected to the mains. It is supplied directly via the DALI signal line.
- A maximum of 12 DALI MSensors must be operated in one DALI circuit.
- DALI is not SELV.
The installation instructions for mains voltage therefore apply.
- Please ensure that the detection range of the sensor lies in the lighting area of the controlled luminaires.
- Please ensure that the detection ranges of the sensors do not overlap.
This may have influence to the lighting control.
- When installed at a height other than the recommended installation height (2.5 m), the presence sensor might show different characteristics.
When mounted at a higher level, its sensitivity is reduced.
If mounted at a lower level, its range is diminished.
- Heaters, fans, printers and copiers located in the detection zone may cause incorrect presence detection.
- Avoid direct illumination of the light source on the sensor including housing.

3.1 Wiring

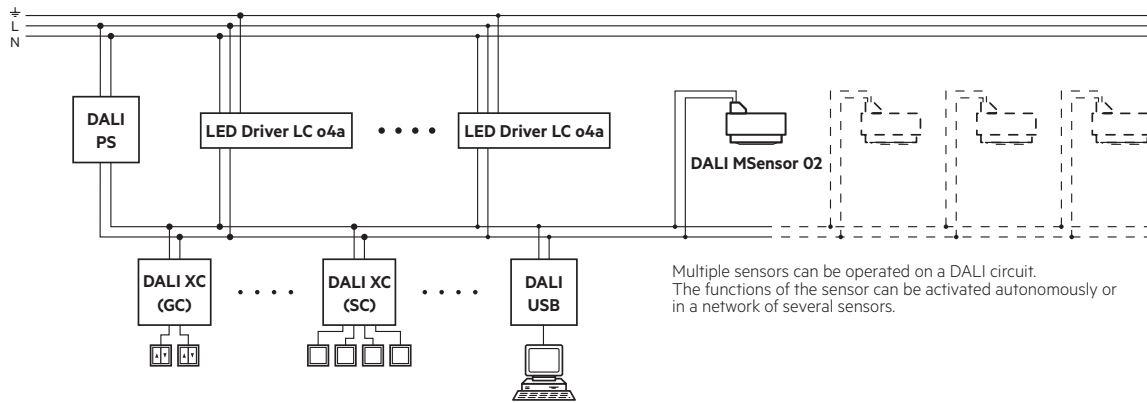

3.2 Wiring type and cross section

The wiring can be solid wire or stranded wire with a cross-section of 0.5 mm² to 1.5 mm².

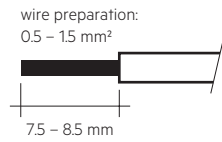

4. Light level recognition area

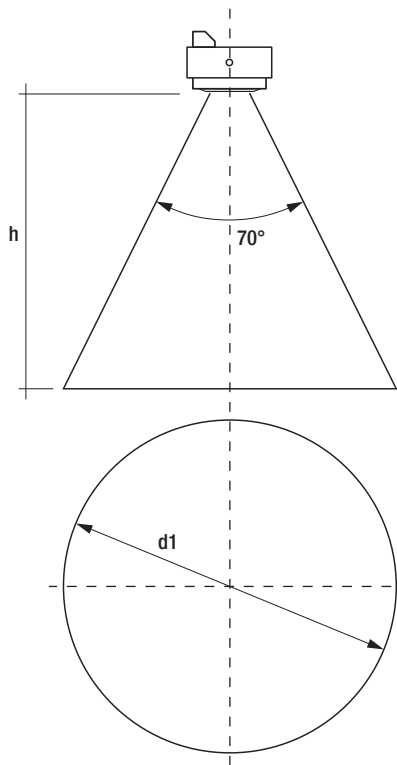

| h * | d1 | d2 | d3 |
|-------|-------|-------|--------|
| 1.7 m | 2.4 m | 3.4 m | 1.36 m |
| 2.0 m | 2.8 m | 4.0 m | 1.60 m |
| 2.3 m | 3.2 m | 4.6 m | 1.84 m |
| 2.5 m | 3.5 m | 5.0 m | 2.00 m |
| 2.7 m | 3.8 m | 5.4 m | - |
| 3.0 m | 4.2 m | 6.0 m | - |
| 3.5 m | 4.9 m | 7.0 m | - |
| 4.0 m | 5.6 m | 8.0 m | - |

* The recommended maximum room height for office applications is 3 m and for corridor applications for example 4 m.

Calculation of the diameter:
 $d = 2 \times \tan(0,5 \times \alpha) \times h$

The following operating modes can be set for lighting control via the masterCONFIGURATOR configuration software:

| | |
|----------|---|
| Active | Constant light control is active. |
| Inactive | Constant light control is deactivated. The lighting is switched on an adjustable light value. |

4.2 Setpoint adjustment

- REMOTECONTROL IR6: Pressing the Set button stores the current light value as a new setpoint.
- masterCONFIGURATOR

4.3 Bright-out

If the nominal illuminance (e.g. 500 lux) is exceeded for 10 minutes by more than 150 % (e.g. 750 lux), the lighting is switched off even if motion is detected. The lighting is switched on again when the measured light value falls below the setpoint.

This function can be adjusted via the masterCONFIGURATOR.

4.4 Run-on time

This is the time after which the lighting is switched off if no movement is detected. It can be set via the "Run-on time" parameter.

4.1 Motion detection (d2) and presence detection (d3)

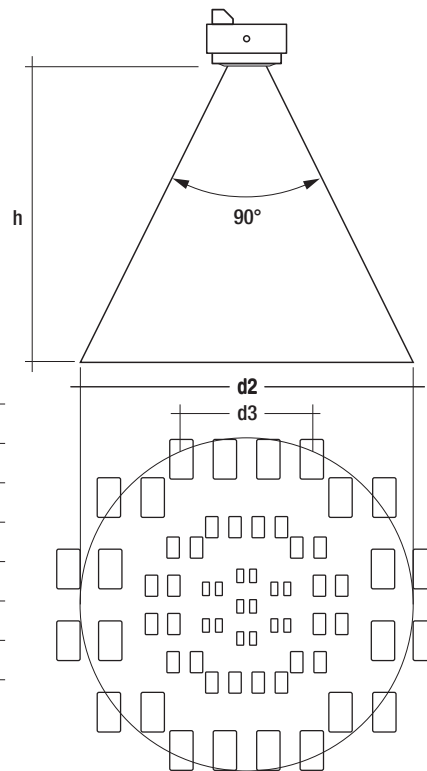

The following operating modes can be set for the motion detector via the masterCONFIGURATOR configuration software:

| | |
|-----------|---|
| Active | The light is switched on or off automatically depending on whether or not there is a person in the room. |
| Off Only | The motion detector only switches the connected lighting off. The luminaires are switched on manually via the connected external switch or infra-red control. |
| Never Off | If it has not detected any movement the sensor dims to the "Absence value" parameter and remains at this value |
| Inactive | The motion sensor is deactivated. The light must be switched on or off manually. |

4.5 Absence value

On the DALI MSensor 02 you can set whether the light is to be switched off after the switch-off delay or dimmed to the second light value. The light value and the dwell time (how long the value is held) can be set via the "Absence value" and "Switch-off delay" parameters.

4.6 Dead time "Manual-off"

If the system is switched off manually via the switch or remote control the motion sensor is deactivated. At the end of a delay time if motion has not been detected the motion sensor is activated again. If the sensor detects motion during the "Manual-off" delay, the time will be reset to the start.

4.7 General settings

| Parameter | Default Values | Adjustable range |
|---------------------------|-------------------|---|
| Motion Detector | enabled | enabled, enabled (only OFF), disabled |
| Light Regulation | enabled | enabled, disabled |
| Setpoint Light Regulation | 150 lx | 10 – 650 lx |
| Power On Setting | no action | no action, last state, maximum level, off, presence value |
| Bright-out timeout | 10 min | 1 – 120 min |
| Bright-out threshold | 150 % | 100 – 300 % |
| Control Speed | 4 | 0 – 7, 0 = slow, 7 = fast |
| Switch On Value | auto (calculated) | minimum level, maximum level, calculated |
| Rotary Switch | 0, Broadcast | 0 (Broadcast), 1 – F (Group 0 – 14) |

4.8 Default Parameter Motion Detector

| Parameter | Default Values | Adjustable range |
|--------------------|--------------------------|---------------------------------|
| 1 Fade-in time | fast | fast, 0,7 – 90,5 s |
| A Presence value | ambient light-controlled | ambient light-controlled, fixed |
| 2 Run-on time | 20 min | 30 s – 60 min, infinite |
| 3 Fade time | 5,6 s | fast, 0,7 – 90,5 s |
| B Absence value | 3 % | 1 – 100 % |
| 4 Switch-off delay | 10 min | 0,7 s – 60 min, never OFF |
| 5 Fade-off time | 5,6 s | fast, 0,7 – 90,5 s |
| Manual-off | 10 min | fast, 0 s – 20 min |

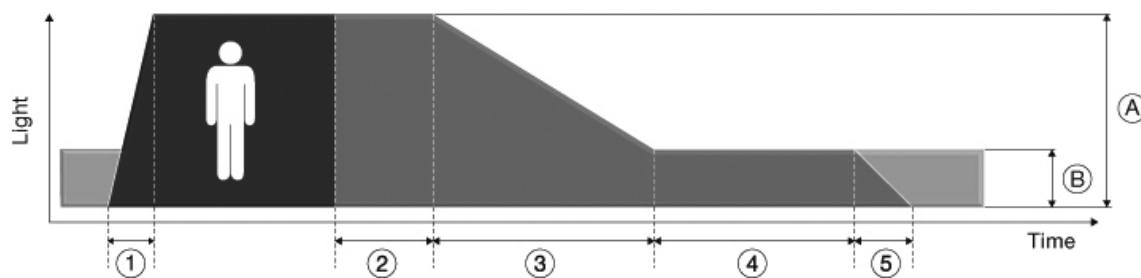

4.9 Operating area (grouping)

The setting of the operating area is done with the rotary switch which is at the backside of the DALI MSensor 02. All devices in the setted operating area will be controlled by the sensor.

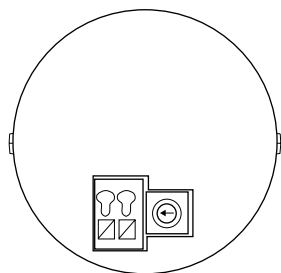

| Position | Luminaire Group |
|----------|-----------------|
| 0 | Broadcast |
| 1 | DALI Group 0 |
| 2 | DALI Group 1 |
| 3 | DALI Group 2 |
| 4 | DALI Group 3 |
| 5 | DALI Group 4 |
| 6 | DALI Group 5 |
| 7 | DALI Group 6 |
| 8 | DALI Group 7 |
| 9 | DALI Group 8 |
| A | DALI Group 9 |
| B | DALI Group 10 |
| C | DALI Group 11 |
| D | DALI Group 12 |
| E | DALI Group 13 |
| F | DALI Group 14 |

5. Remote control

The DALI MSensor O2 can be controlled with a remote control:

- REMOTECONTROL IR6

5.1 REMOTECONTROL IR6

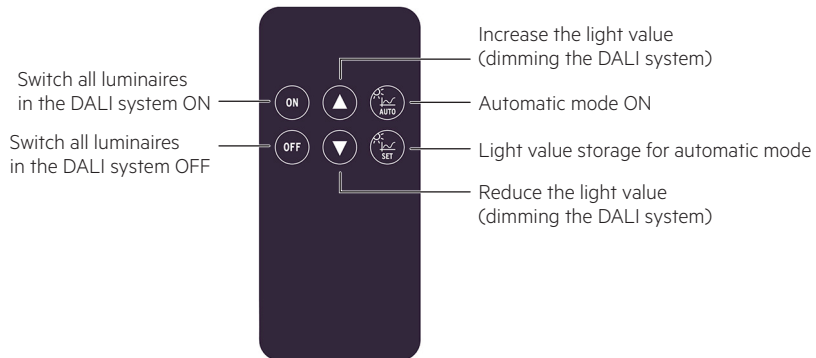

6. Miscellaneous

6.1 Disposal



According to the WEEE directive return old equipment at appropriate collection facilities.

6.2 Additional information

Additional technical information at www.tridonic.com → Technical Data

Guarantee conditions at www.tridonic.com → Services

Life-time declarations are informative and represent no warranty claim.
No warranty if device was opened.